

OWNER'S MANUAL

Add-a-Motor, Inc. Model D20 Motor

Automatic motor lifts & lowers small doors.
Applications: Chicken coop, pet doors, etc.

Timer and X-10 Compatible.
Read Entire Manual Before Using.
Save For Future Reference.
US Patent 4958112 applies.
Manufactured by Add-a-Motor, Inc.

Thank you for purchasing this Add-a-Motor product. We sincerely hope that you enjoy years of convenience and reliable service.

INDEX

Features and Battery Option	1
Safety Information	1
Timers and X-10	1
How Motor Operates	2
Installation Instructions	2-3
Timer Operation	3
Remote Control Operation	3
Trouble Shooting	4
Battery Tips	4
Periodic Inspection	4
Warranty	4
Customer Service	4
Repair	4

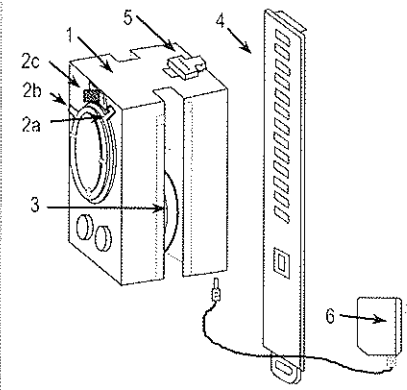

Furnished components

1. Housing
- 2a. Actuator (Tipped)
- 2b. Actuator (Flat)
- 2c. Stop Switch
3. Reel
4. Wall Bracket
5. Lock
6. AC-DC Adapter
7. Lift-Cable (not shown)

FEATURES

Applications: Chicken coop doors, pet doors, small apparatus that moves up and down.

Motor lifts and lowers a door up to 4 pounds, with door openings up to 25 inches. Door not included.

IMPORTANT: Wood doors can swell, jam and damage motor. Use plexiglas, aluminum or tempered masonite door material.

Motor winds a cable on and off a reel similar to a fishing reel.

Motor automatically stops at open and closed door positions you set.

Motor can be operated by AC timer switch, remote control, and X-10 control (control not furnished).

Motor can also be operated by battery and 12-volt timer. Build your own system including timer for about \$75. You can also add a Solar Charger for convenience and "green" energy independence.

12-volt Timer:	www.cabelas.com In Search Window enter " IA-226720 "	12-volt Digital American Hunter Timer
Battery:	www.cabelas.com In Search Window enter " IK-018049 "	12-volt battery + AC-DC charger
Solar:	www.basspro.com In Search Window enter " 38-830-842-00 "	12-volt, 1 Watt Solar Charger

Note: Above components successfully used to power D20 motors in remote areas. Above timer is available in analog and digital versions. The analog timer does **not** receive good customer ratings. We used the digital version with good results. Timer has terminals to connect battery, motor and solar charger. Solar charger elective. We added a 12 volt solar charger from www.basspro.com. With it, the battery remained charged. Without solar charger, battery needed monthly charging; more often in winter and northern geographic locations. Add-a-Motor is not affiliated with American Hunter, cabelas.com or basspro.com.

There are other timer, battery and solar charger brands available by searching the Internet. Following are the correct 12-volt specifications.

12-volt Timer: Digital or analog. Label rating or advertising **must** include any of the following ratings: "appliance, motor, fan, pump, HP, 1/4". A Timers without one of these causes problems. **Never** use timer with "adjustable (low, med, hi) motor speed control". AC timer examples below.

Battery rating: 12-volt, 8 Ah (Amp-hours) or more.

Solar Charger rating: 12-volt to 18-volt, 1 Watt to 2 Watts.

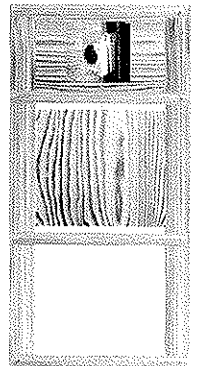

GENERAL SAFETY INFORMATION

Symbols and notices are for your protection. **WARNING** Small parts pose swallow-inhalation hazard; during installation keep children, pets and chickens away. If any part of body, hair, or clothing becomes entangled while motor operates, immediately actuate Stop Switch 2c and unplug Adapter. Do not oil, modify or disassemble. Product may operate unexpectedly if controlled by timer or remote control. After installation, check all connections and lift-cable knots. Regularly observe operation to verify it performs to your expectations. Replace Lift-Cable if inspection reveals wear that could interfere with reliable operation.

AC TIMERS AND X-10 CONTROLS (Many other AC electric timer brands are available. Preferred type has battery backup to preserve time of day.)



Outdoor Timer



Indoor Digital AC
Timer/Battery backup



X-10 AC Timer/Battery backup
+ Remote Control-in-One



X-10 AC Appliance Module.
One required for each motor.



12-volt Digital Timer for battery
system Item IA-226720 at
www.cabelas.com

- ❖ Select a Control Switch appropriate to your application and location.
- ❖ Timer **MUST HAVE** minimum of 2 ON and 2 OFF settings each 24 hour period. **NEVER** use a timer with dimming feature.
- ❖ AC timer **MUST** be labeled with at least one of the following ratings: : **Appliance, motor, fan, pump, HP, 1/4, or 1/3.**
- ❖ X-10 systems: **ONLY** use an Appliance Module. **NEVER** use X-10 Lamp Module. **NEVER** use device with a dimming feature.

CAUTION Failure to comply with the above can damage Motor AC-DC power supply and void your warranty.

CAUTION To avoid damage or short-circuit, mount motor under-roof, and if appropriate shield with a water-resistance barrier.

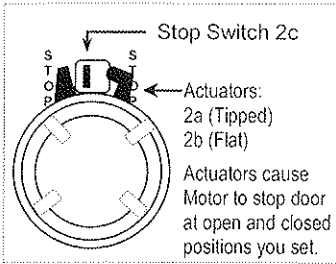

HOW MOTOR OPERATES

- Stop Switch 2c is similar to a light switch. However, it only stops the motor; it cannot start the motor.
- When the motor runs, one Actuator moves toward the Stop Switch while the other moves away.
- The Stop Switch is moved automatically by Actuators 2a and 2b. Switch can also be operated manually by hand.
- When an Actuator moves the Stop Switch from one-side to the other, the motor stops.
- After motor stops, motor will not run again until power is turned OFF for at least 3 seconds.
- When power is turned back ON, motor runs in opposite direction until the other Actuator moves the Stop Switch.
- Power is turned ON and OFF by a timer, remote control, or other control switch sold separately.
- User adjusts Actuators closer to, or farther away from Stop Switch to set desired open and closed stop positions.

TEST MOTOR BEFORE INSTALLING

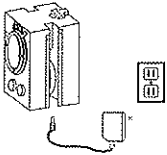

- Start by setting BOTH Actuators close to Stop Switch 2C as shown above. Actuators are tight – rotate by hand.
- **CAUTION:** Motor will run immediately in next step. Lift-Reel will rotate. Keep fingers and clothing away.
- Insert round plug on AC-DC Adapter cord into receptacle at bottom of motor. Then plug Adapter directly into an AC electric outlet.
- Watch both Actuators when motor runs. One will move toward the Stop Switch, the other moves away. Allow motor to stop itself.
- Unplug AC-DC Adapter. Wait 3 seconds, then plug Adapter in again. Above process will repeat but in opposite direction.
- Repeat above. Note that each time AC power is On, motor runs then automatically stops itself, even if AC power remains On.
- When AC power is switched Off, motor electronics reset, and motor will run in opposite direction when AC power comes On again.

INSTALLATION STEPS

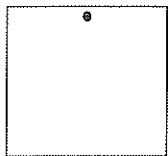
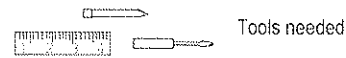

IF YOUR DOOR IS A SWING-OPEN TYPE, FIRST CONVERT IT TO VERTICAL LIFT-LOWER.

1. Mark center-line of door on inside as shown. Then make a mark near top of door on the center-line.
2. Attach a cup-hook (not furnished) to inside of door on your mark. Alternate: Drive nail thru door from outside until nail head is flush with outside of door. On inside of door bend nail end over as illustrated. **Note:** Motor should be installed inside coop to protect it from the elements.

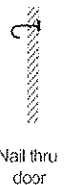

CAUTION VIP: Cup hook, nail, etc. must not protrude to the outside portion of door, and it must not have sharp edges such as screw-threads that can cut the Lift-Cable. Verify that door moves freely up and down and does not jam, otherwise motor damage can occur.

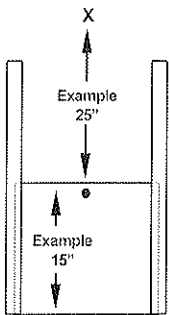

3. Measure your overall door height, then add 10 inches. See example at left.
4. From top of door, measure up wall the number of inches you determined in Step 3 above. Example: 15" + 10" = 25". Make mark on wall 25" above top of door. **VERIFY** that mark is directly above door center-line and on same plane when viewed from side.

NOTE: Wall Bracket has front and rear side. Tabs on rear go against wall.

5. Position the **vertical oval hole** in Wall Bracket over your mark on wall. Drive a screw into wall through this hole. Make Wall Bracket vertical, then drive a second screw through **horizontal oval hole** below first screw.

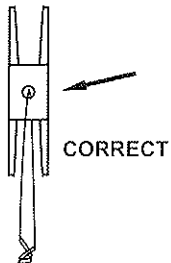
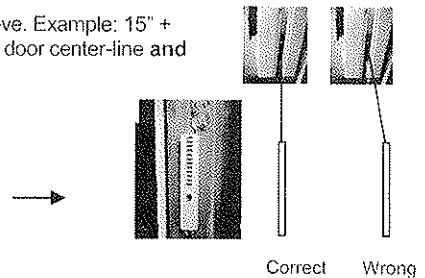

6. Thread the supplied Lift-Cable **halfway** through hole in Motor Reel. Bring cable ends together so both are equal lengths. Tie ends together with 2 knots. Next, twist knotted end about 20 times clockwise. The result is a double thickness of cable twisted together with a knotted end.

NOTE: A sixty (60) inch length of Lift-Cable (80# test fishing line) is supplied. If your Step 3 measurement exceeds 30 inches, you may need to lower Wall Bracket, or furnish a longer Lift-Cable.

CAUTION LIFT-CABLE SPECIFICATIONS: **ONLY USE 80# OR 100# TEST FISHING LINE. NEVER USE METAL CABLE OR NYLON CORD BECAUSE MOTOR DAMAGE WILL OCCUR AND VOID YOUR WARRANTY.**



7. Slide motor onto Wall Bracket and lock in place using Latch at top of Motor. Leave four (4) ladder slots visible above motor for future adjustment.

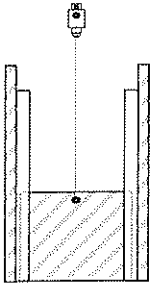

8. **IMPORTANT** Pull Lift-Cable taut at knot end, Verify that Lift-Cable has been twisted about 20 times. Next, with door in closed position, tie knotted end of Lift-Cable to door hook **using 2 or more knots.**

NOTE: If Lift-Cable is slack, raise Motor in Wall Bracket and lock at higher position. Or, you can plug AC-DC Adapter into motor to **immediately** start motor and wind-up slack ... **BUT FIRST READ STEP 9 BELOW.**

9. **⚠ WARNING** MOTOR WILL OPERATE IMMEDIATELY IN THIS STEP. DO NOT PROCEED UNTIL YOU FIRST READ ALL INSTRUCTIONS INSIDE THE FOLLOWING BOX

DOOR MUST BE CLOSED.

SET BOTH ACTUATORS NEAR STOP SWITCH 2C.

9. **PLUG ADAPTER DIRECTLY INTO A 120VAC OUTLET. BE READY TO UNPLUG ADAPTER.**

Motor will wind-up Lift-Cable onto Motor Reel. If Cable is slack, pull down on it until Motor begins to lift door.

- If door reaches desired Open position IMMEDIATELY UNPLUG Adapter. Then do the following. Manually move Stop Switch 2c from its present position to the opposite side. **DO NOT MOVE IT BACK.** If you moved the Switch to the left ← rotate **TIPPED** Actuator 2a until it touches the Switch. But if you moved the Switch right → rotate **FLAT** Actuator 2b until it touches the Switch.

- If door stops before reaching desired Open position, measure the remaining distance to desired Open position. Example: Remaining distance to desired Open position = 8". Then, rotate "controlling" Actuator 8 clicks AWAY from the Switch. The "Controlling" Actuator will be nearest the Switch. Unplug Adapter from wall outlet. Wait 2 seconds. Plug it in again. Motor will run in opposite direction and should close fully.

Repeat above procedure until desired door stop positions are set. **Fine adjustments can be made by moving Motor up or down in Wall Bracket.**

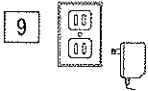

9. To increase travel distance, rotate "controlling" actuator 1-click away from Switch. To decrease, rotate it closer. Travel distance is about 1" per click.

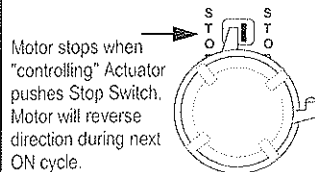

10. **PLUG AC-DC ADAPTER INTO A TIMER OR REMOTE CONTROL RECEIVER. PLUG BOTH INTO AN AC OUTLET. FOR BATTERY POWERED SYSTEM REFER TO "BATTERY TIPS" ON NEXT PAGE, BUT STILL READ ALL OF THIS STEP.**

Timer Operation - Timer MUST have a minimum of 2 ON and 2 OFF settings. (Timer available separately)

Set Timer to correct time of day, noting AM and PM setting. Set door in closed position.

HOW TO SET DOOR TO AUTOMATICALLY OPEN EACH MORNING

- Set Timer ON setting for the time of day that you want door to open. Example: 6:30 AM.
- Set Timer OFF setting as soon as possible after the ON setting. Example: 7:00 AM.
- **Timer Switch must be set to switch OFF after every ON, otherwise motor will not run again.**

HOW TO SET DOOR TO AUTOMATICALLY CLOSE EACH EVENING

- Set Timer ON setting for the time of day that you want door to close. Example: 7:30 PM.
- Set Timer OFF setting as soon as possible after the ON setting. Example: 8:00 PM.
- **Timer Switch must be set to switch OFF after every ON, otherwise motor will not run again.**

HOW TO SET MULTIPLE DOOR OPENING AND CLOSING TIMES

- Repeat above procedure and set one ON setting for each time of day that you want door to move. **Always set an OFF after every ON.**

NOTE: To open or close sooner than a preset time, turn Timer's manual switch to ON. Motor will operate and stop at set position. To return to original open/closed schedule, **leave timer ON** or return it to **AUTO** and allow it to go through scheduled cycle. When next ON occurs, motor will ignore it because electronics are already ON. The next OFF will then reset the original sequence.

NOTE: Motor will not be damaged if timer allows only an OFF setting 1+ hour after each ON setting.

10. Plug Adapter into timer switch. Plug both into wall outlet.

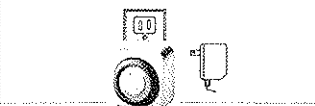

10. Plug Adapter into remote control receiver. Plug both into wall outlet.

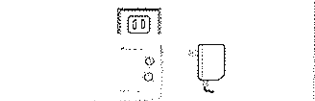

Remote Control Operation (Remote control available separately)

- Plug AC-DC Adapter into remote control Receiver then plug Receiver into wall outlet. Press transmitter ON button until motor starts, then release button. Door will move to set position then automatically stop. If motor does not stop at desired position, press OFF button and repeat Step 9.
- After motor stops at set position, press OFF button to reset Motor electronics. **Motor will not run again unless OFF is pressed.** Wait 2 seconds before pressing ON button.
- To move door to opposite position, press ON button.

AAM- 89717 04-10

TROUBLE SHOOTING Following steps apply to both AC and Battery operated motors.

Motor operates erratically, or does not operate.

- ◆ **Test as follows:** Plug furnished AC-DC Adapter directly into AC electrical outlet. Motor should operate. Allow motor to run until it automatically stops. Unplug Adapter and repeat this step several times. If motor works during this step, your battery voltage is low, or your timer is causing problem.
- ◆ Push Switch 2c to opposite side then back, and repeat quickly several times. Plug motor in and retry.
- ◆ UL safety fuse inside AC-DC Adapter opened. Check using other UL Listed **unregulated** AC-DC Adapter with DC output of 12 volts, 1 amp. Output plug must be center-positive. You can also test Adapter output using a voltage tester. Voltage should be 17-volts or more, but not over 20-volts.
- ◆ Verify that your AC outlet is providing power by plugging a lamp into the outlet and switch it On. Also see "battery maintenance" in following section.

Open – closed sequence has reversed.

- ◆ An electric power failure can change Timer settings. Verify AM-PM, time of day setting and that an OFF setting follows every ON.
- ◆ Timed event preempted. Refer to Step 10.

BATTERY TIPS Appropriate battery: 12-volts, 5Ah to 8Ah rating. Appropriate solar charger: 12 to 18-volts, 1 watt to 2 watts.

- 1) Fully charge battery using correct AC-DC charger. **WARNING** Do not use Adapter furnished with D20 motor.
- 2) Obtain an unneeded AC-DC Adapter that has a center-positive plug that fits the motor power jack. Next, cut cable off unneeded Adapter leaving several feet attached to plug. Remove ½" insulation from cable ends and correctly connect positive and negative leads to timer terminals. Wrap connection with electrical tape to prevent short-circuit. Plug opposite end into motor power jack. **Note:** If you decide to cut cable and plug off Adapter furnished with the D20 motor, doing so voids Adapter warranty. However, Adapter can still be used in the future if you splice cable ends back together in exact same polarity.
- 3) Follow Timer instructions to set time of day. Next, set a time schedule to open/close coop door. **Note:** The timer recommended on page 1 has a "feed duration" setting of 3 to 30 seconds. Set it to 30 seconds, which means that after 30 seconds timer will automatically switch to OFF, therefore you do not need to set a separate OFF setting. **VIP:** For all other timers, you **MUST** set a Timer OFF setting after every ON setting; otherwise, motor will not run again. The OFF setting can occur 30 seconds to 1 hour after each ON setting.
- 4) Press Timer 'test' or 'On' button. Motor should run immediately. If motor runs in wrong direction, reverse cable leads to motor.

Optional) If solar charger used, connect its positive (red) alligator clip to battery positive post, then black to battery negative post. Aim solar panel toward sun's midday travel arc. Affix to coop at appropriate tilt angle. For peak performance, periodically clean front of panel.

Battery maintenance: Batteries are not weather proof. Snow-rain can short terminals. Keep covered but ventilated. Check voltage level periodically.

- ◆ If 14.5 volts or higher, temporarily unplug solar panel if in use. Overcharging can damage battery.
- ◆ If 10.9 volts or lower, disconnect and charge. Inspect in a week. If 10.9 volts again, charge again, add additional solar panel, or replace battery.

PERIODIC INSPECTION

An electric power interruption can change time of day setting of your Timer. Check Timer time-of-day setting, and ON/OFF settings; Step 10.

Lift-Cable can stretch. Check Lift-Cable knots. Check door operation to verify that it opens and closes as desired.

If Lift-Cable becomes frayed, replace it **ONLY** with 80# or 100# test fishing line.

WARNING NEVER REPLACE LIFT-CABLE WITH METAL CABLE OR NYLON CORD BECAUSE MOTOR DAMAGE WILL OCCUR.

LIMITED WARRANTY AND CUSTOMER SERVICE

Product is warranted against defective materials for one year from date of purchase. For warranty service, please follow below procedure.

- **Call 888-233-6686** (8:30 AM to 4:00 PM Arizona time, weekdays), or email to info@add-a-motor.com. Request a Return Authorization Number.
- Carefully pack and seal defective item. **Ship or mail PREPAID to:** Add-a-Motor, Inc. 16044 E Star Gaze Trail, Fountain Hills, AZ 85268.
- Write your return address and Return Authorization Number on outside of package. Inside package include the following:
 - 1) Copy of dated proof of purchase (keep original).
 - 2) An explanation of the problem and your Return Authorization Number.
 - 3) Your name, address and telephone number (**very important**).

Warranty void if AC-DC Adapter is plugged into receiver or timer control switch rated only for lamp use. Lift-Cable not covered by any warranty. Warranty void if product modified. Warranty applies only to original purchaser. Adapter warranty 90 days from date of purchase. Product failure caused by any reason not related to product materials is not covered. Add-a-Motor disclaims liability for use of this product that results in property damage and injury or death to persons or animals whether or not product is defective, misused, abused, neglected or acts of God. No employee, agent, dealer or other person is authorized to give any warranty on behalf of Add-a-Motor, Inc. If our inspection reveals that problem was caused due to materials within the limits of this warranty, Add-a-Motor will repair or replace product free of charge. Replacement unit is under warranty for the remainder of the original warranty period. Add-a-Motor makes no other warranty of any kind. Any expressed or implied warranty including merchantability and fitness for a purpose which exceeds the obligation in this warranty are disclaimed and excluded in all respects. User is responsible for selecting control switch appropriate for application; Add-a-Motor is not liable for how product is used or controlled. The sole obligation of Add-a-Motor is to repair or replace product at our discretion. Add-a-Motor is not liable for incidental, consequential, or any damage, loss or injury due to use or misuse of product whether or not product is found defective for any reason.

REPAIR

Product damage is not covered by warranty. If motor becomes damaged, you might repair it yourself and save labor and return shipping cost. The following parts are snap-in with some screwdriver assembly required. Call us toll-free 1-888-233-6686 to order needed part.

- | | | | |
|-------------------------|------------------------------------|-----------------------|---------------------------------------|
| 1. <u>Gearmotor</u> | <u>Repair skill level - basic.</u> | <u>Item No. 46555</u> | <u>Cost \$21.50; add UPS shipping</u> |
| 2. <u>AC-DC Adapter</u> | <u>Repair skill level - none.</u> | <u>Item No. 78907</u> | <u>Cost \$19.55; add UPS shipping</u> |

Please call us to obtain a Return Authorization Number before you return a motor. If we determine that motor is defective it will be repaired or replaced at no-charge. If damage repair is needed, cost ranges from \$29.95 to \$34.95 including parts and labor. Thank you again for purchasing our product.