

Electric Door Strike with Vertical Adjustment

SD-996C-NUVQ

12/24 VDC/VAC, Fail-Safe or Fail-Secure, UL Listed

The SECO-LARM SD-996C-NUVQ Electric Door Strike with Vertical Adjustment is compatible with a wide range of lock types including cylindrical, mortise, and mortise exit devices and can be configured for use in wood, aluminum, or metal doors. Included are various ANSI-sized faceplates to match the door lock type. The strike is easily field-configurable for fail-safe or fail-secure applications.



Features:

- 12/24 VDC Operation
- Vertical adjustable deadbolt opening, sliding shim keeper, and deadlatch ramp accommodates a wide range of lock types
- Accommodates deadbolts up to 1"
- Field selectable for fail-safe or fail-secure
- Includes 5 different stainless-steel faceplates
- Includes trim plate to hide gaps in installation
- Reversible non-handed design
- Static strength – 1,000 lbs. (454kg)
- Tested to 250,000 cycles (UL Tested)
- Low current draw: 300mA@12VDC & 150mA@24VDC

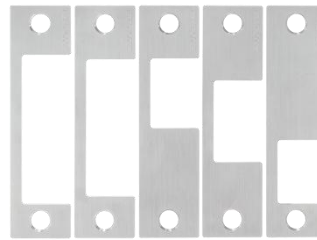

Five Faceplates Included (see back for details)

Specifications:

Operating voltage	12/24 VDC	
Current draw	12VDC	300mA
	24VDC	150mA
Operating temperature	14°~113° F (-10°~45° C)	
Operating humidity	0~85%	
Static strength	1,000 lbs. (454kg)	
Dynamic strength	33 ft-lbs. (4.56 m-kgs)	
Latch throw	1" (25mm) max with 1/8" (3mm) door gap	
Dimensions	1 13/16" x 1 5/8" x 3 5/16" (47x42x84 mm)	

Dimensions:

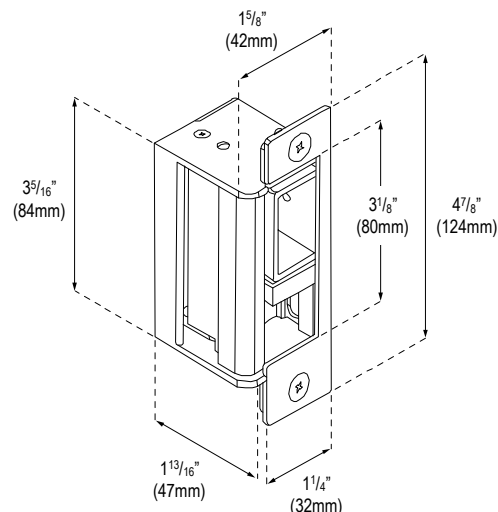

SECO-LARM® U.S.A., Inc.

16842 Millikan Avenue, Irvine, CA, 92606

Phone: (949) 261-2999 | (800) 662-0800 Fax: (949) 261-7326

Website: www.seco-larm.com Email: sales@seco-larm.com



Copyright © 2016 SECO-LARM U.S.A. Inc. All rights reserved. The SECO-LARM policy is one of continual development. For that reason, SECO-LARM reserves the right to change prices and specifications without notice. SECO-LARM is not responsible for misprints.

SECO-LARM® ENFORCER® CRIMEBUSTER® CBA SLI®

PI_SD-996C-NUVQ_161027.docx

Faceplates:

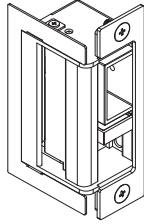

SD-996SS-11D1Q

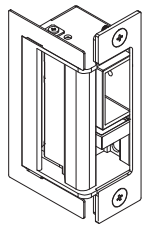
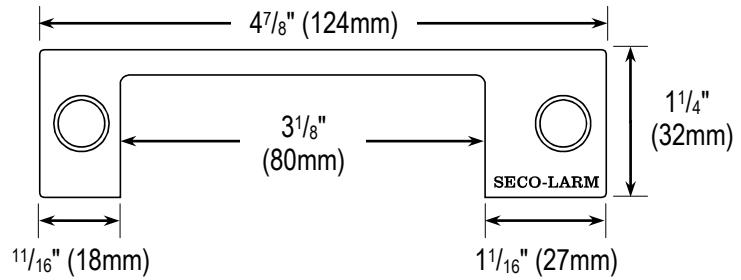

SD-996SS-11D2Q

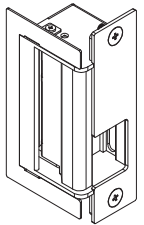
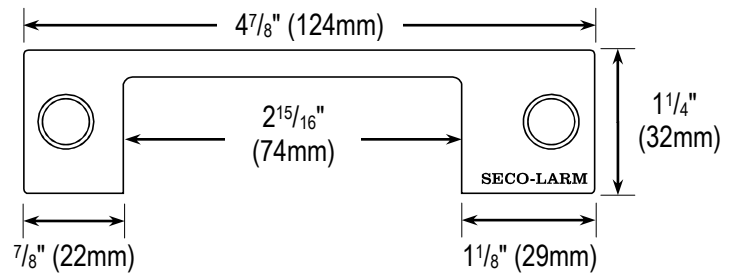

SD-996SS-11L1Q

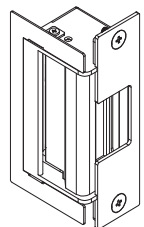
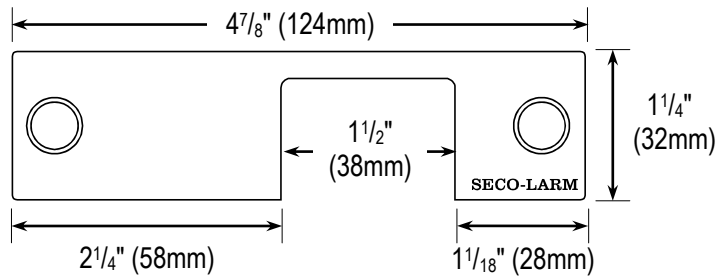

SD-996SS-11L2Q

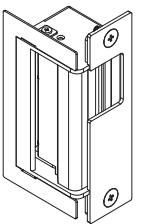
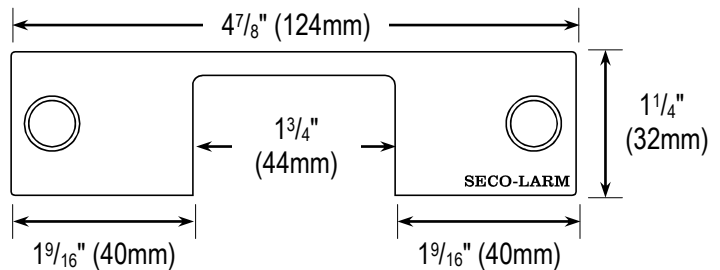

SD-996SS-11L3Q

