



Centralized Distribution for Wired & Wireless Low Voltage Systems

20 Inch Plastic Enclosure with Cover & Trim

30 Inch Plastic Enclosure with Cover & Trim

42 Inch Plastic Enclosure with Cover & Trim

This enclosure secures both structured wiring systems and wireless networking equipment in a professional, out-of-sight installation.

Enclosures: Features & Benefits

- **Wireless Transparent Material** – UL-rated ABS plastic allows wireless devices such as wireless routers, access points or service provider equipment to secure in the cabinet without degrading network performance.
- **Stackable** – Enclosures and doors are each neatly stackable to efficiently ship and warehouse.
- **Surface or Flush Mounting** – Mounts inside a stud bay for a flush finish to wall surface or can be surface mounted.
- **UL Rated** – Meets or exceeds the standards of UL Standard 2416. Specified for non-fire rated walls.
- **Universal Mounting Grid** – Compatible with video, voice and data distribution modules from multiple manufacturers. Ask us for our up-to-date compatibility list.
- **Extensive Venting** – Provides superior heat dispersion for powered devices mounted in the enclosure.
- **Extra Depth** – Hinged Door and Trim add 1.2” (30mm) of enclosure depth for compatibility with more third party devices such as uninterruptable power supplies (UPS).
- **Conceals Drywall Cutout** – Trim Ring conceals the drywall cutout for a professional finish. The reversible Hinged Door attaches to the trim ring and can swing a full 180 degrees.
- **Locking Enclosure** – Locking can be accomplished with the provided screw holes, or a keyed lock may be purchased separately as an option (364478-01)



Enclosure Size	Complete Assembly Enclosure with Hinged Door & Trim	Hinged Door & Trim (Single)	Hinged Door & Trim (5 Pack)	Enclosure Only (Single)	Enclosure Only (5 Pack)
20 Inch	ENP2050-NA	ENP2060-NA	ENP20605-NA	ENP2080-NA	ENP20805-NA
30 Inch	ENP3050-NA	ENP3060-NA	ENP30605-NA	ENP3080-NA	ENP30805-NA
42 Inch	ENP4250-NA	ENP4260-NA	ENP42605-NA	ENP4280-NA	ENP42805-NA

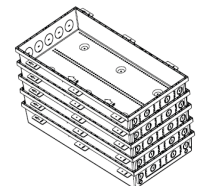
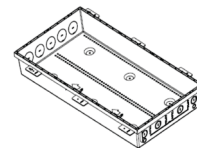
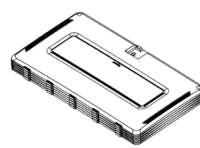

20" Enclosure

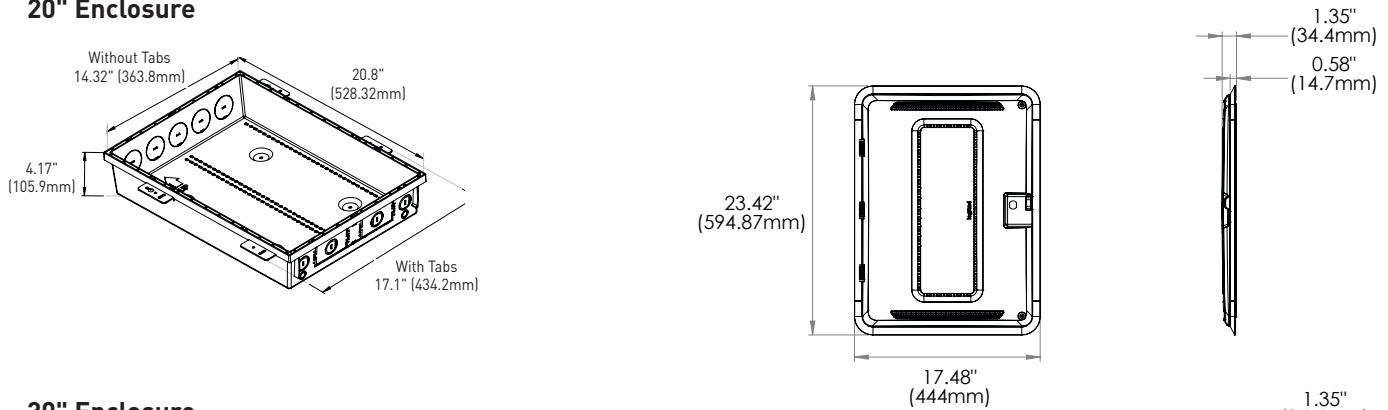

30" Enclosure

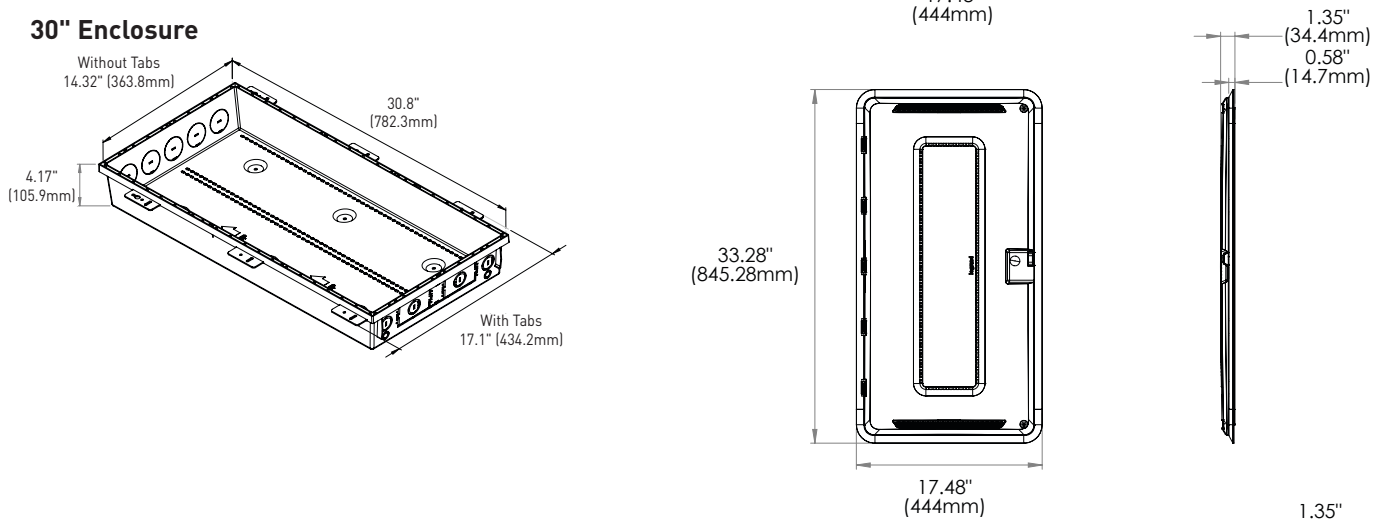

42" Enclosure

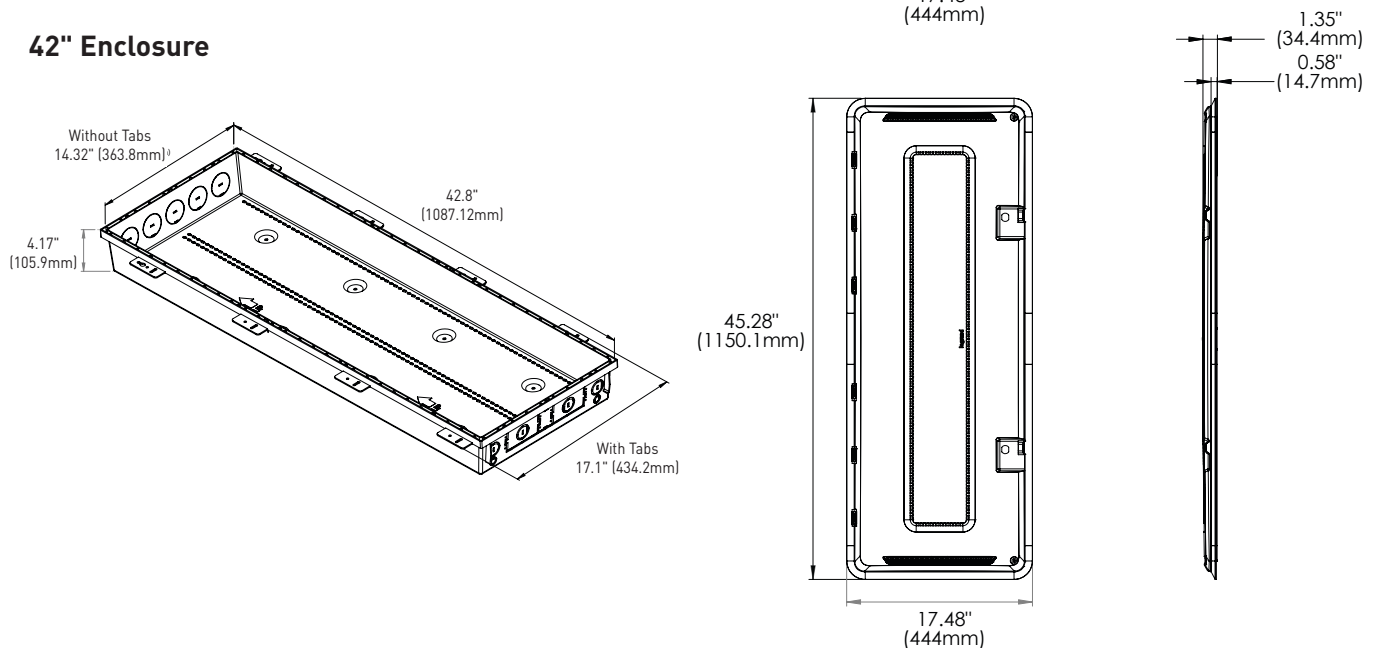

Compliance

- UL 985, Household Fire-Warning System Units. ULC-S545, Residential Fire Warning System Control Units
- UL 1023, Household Burglar-Alarm System Units. CAN/ULC/ORD-C1023, Household Burglar Alarm System Units
- UL 2416, Audio/Video, Information and Communication Technology Equipment Cabinet, Enclosure and Rack Systems
- UL60950-1 & CAN/CSA C22.2 No. 60950-01-07, Information Technology Equipment, Including Electrical Business Equipment
- RoHS Compliant

Accessories

Plastic Enclosure Accessory	Universal Mounting Plate	Fiber Management Spools	Cable Management Clips (20 Pack)	2" Rubber Grommet (5 Pack)	Optional Keyed Lock
	AC1040	AC1041	AC1035-20	AC1034	364478-01

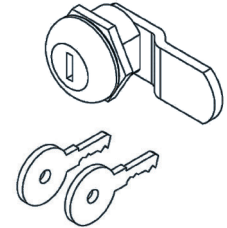
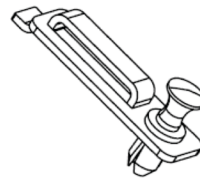
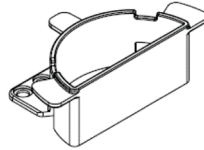
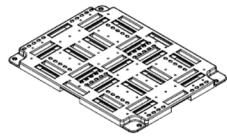
Features & Benefits
AC1040

- **3rd Party Devices** – Allows 3rd party wired and wireless devices to be secured within structured wiring enclosure
- **Multiple Mounting Options** – Vertical and horizontal strapping locations provide a variety of mounting configurations
- **Secure** – Strategically places screw holes allow devices to be securely affixed within enclosure
- **Mounting Hardware** – Includes (4) plungers and grommets and 4' of Velcro strapping – accepts 1/2" Velcro or cable ties

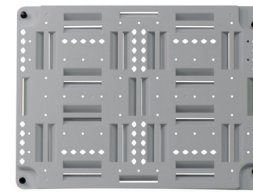
AC1040

AC1041

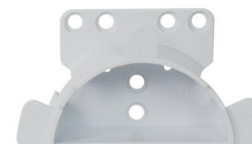
- **Stay Organized** – Neatly organize and manage fiber within structured wiring enclosure
- **Bend Radius Protection** – 1.5" spool radius maintains proper bend requirements for fiber and category cable
- **Versatile Installation Options** – Half round design and multiple mounting holes provide versatile installation options for metal or plastic enclosures
- **Mounting Hardware** – Sold as a pair and includes (4) plungers and grommets and (2) 4" cable ties

AC1041

AC1035-20

- **Clean Installations** – Harness cables within a plastic enclosure for clean installations
- **No Tools Necessary** – Easily attach to the plastic enclosure with included plunger/grommet
- **Secure** – Clips mount securely to enclosure, withstanding 20 lbs pull force
- **Materials** – Pack includes 20 Cable Management Clips

AC1035-20

AC1034

- **Local Compliance** – Local Compliance - 2" Grommet Pack (5) seals knockout when necessary for compliance with local jurisdictions.

AC1034

364478-01

- **Secure** – Keep contents locked and secure with the optional keyed lock for plastic enclosures

364478-01

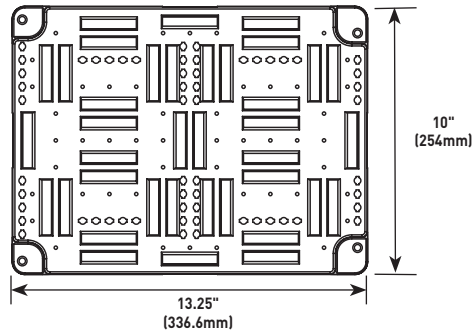
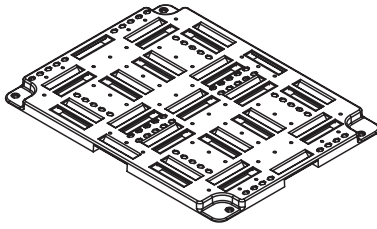

AC1040 – Universal Mounting Plate

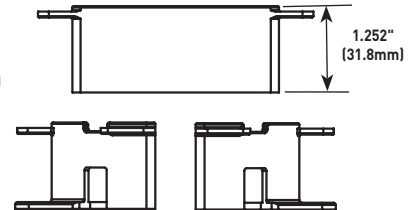
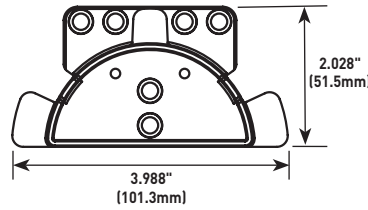
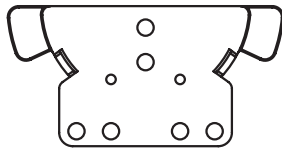
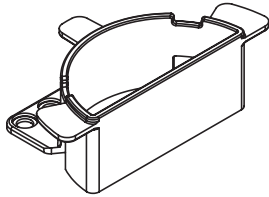

AC1041 – Fiber Management Spools

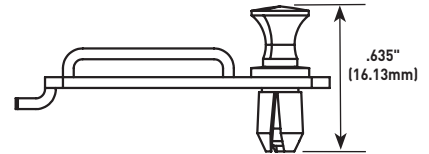
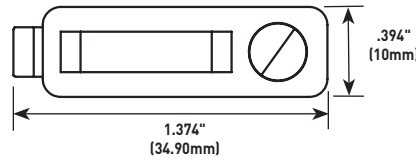
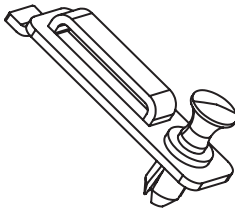

AC1035-20 – Cable Management Clips



AC1034

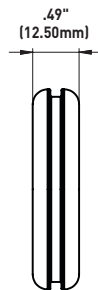
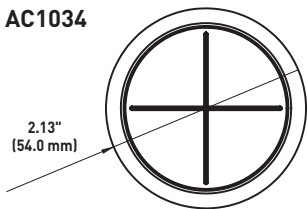

364478-01

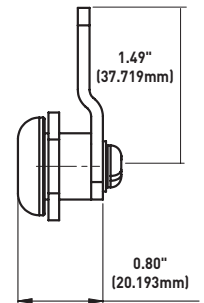
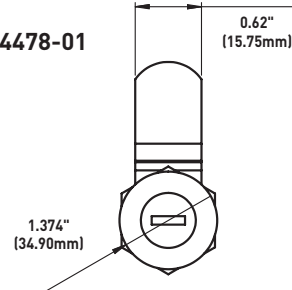

NOTE: The paper used to print this document is an environmentally responsible paper with 10% post consumer waste, with FSC and SFI Chain of Custody certifications, Lacey Act compliant. 100% of the electricity used to manufacture Flo sheets is generated with Green-e certified renewable energy.